



SmartPV遠隔監視装置

高圧接続イメージ図

2018年7月

TAOKE

目次

CONTENTS

1 HUAWEI製PCSとの接続

2 デルタ電子製PCSとの接続

3 その他PCSとの接続

HUAWEI製PCSと直結 (PCS11台まで+気象センサー1台計12台)

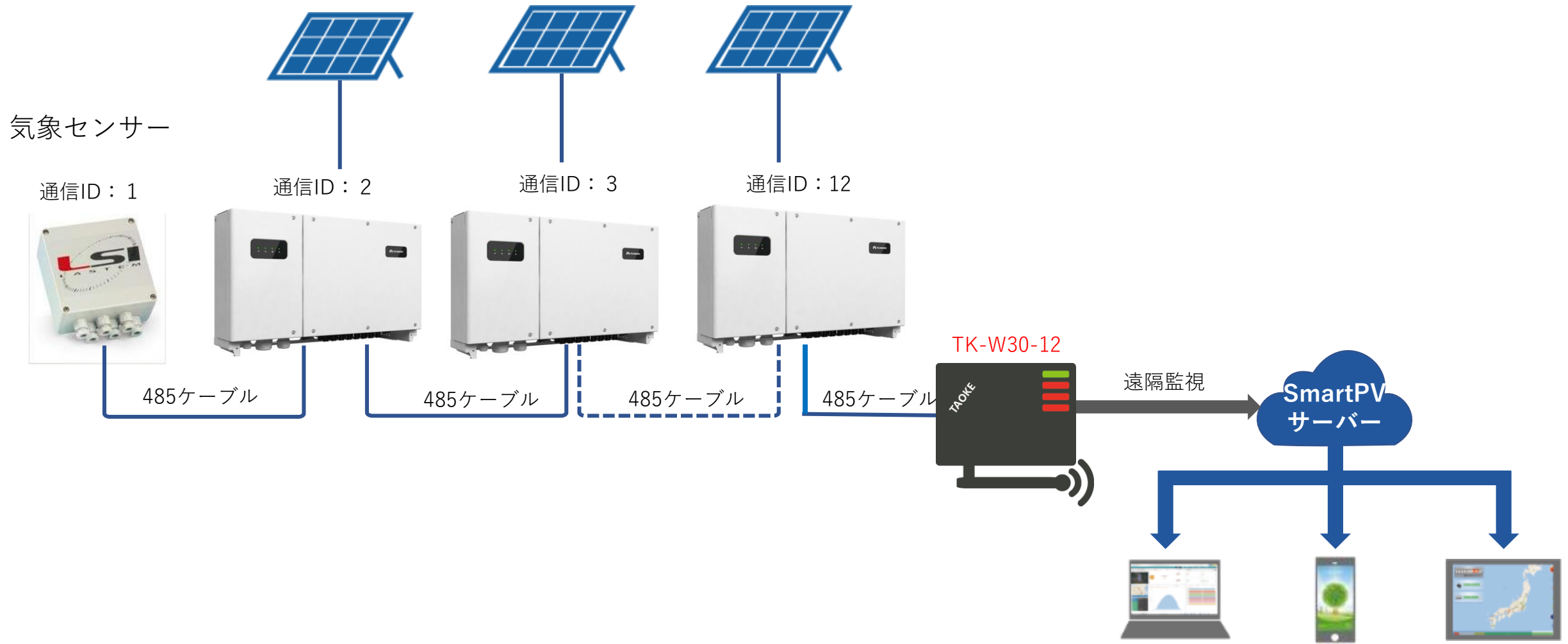

HUAWEI製PCSと直結 (PCS12台超えた+気象センサー1台)

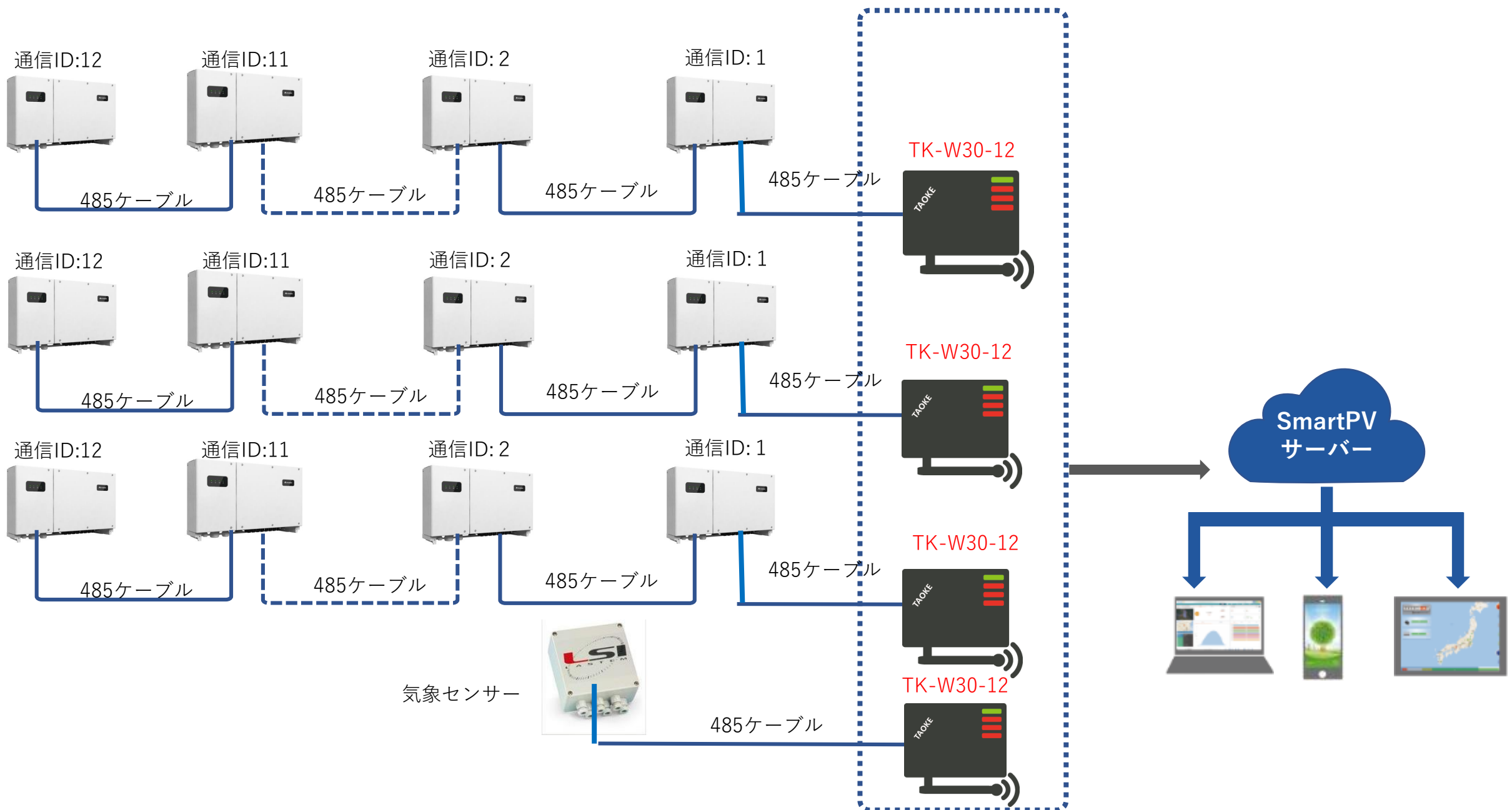

Smartloggerと直結 (PCS11台まで+気象センサー1台計12台)

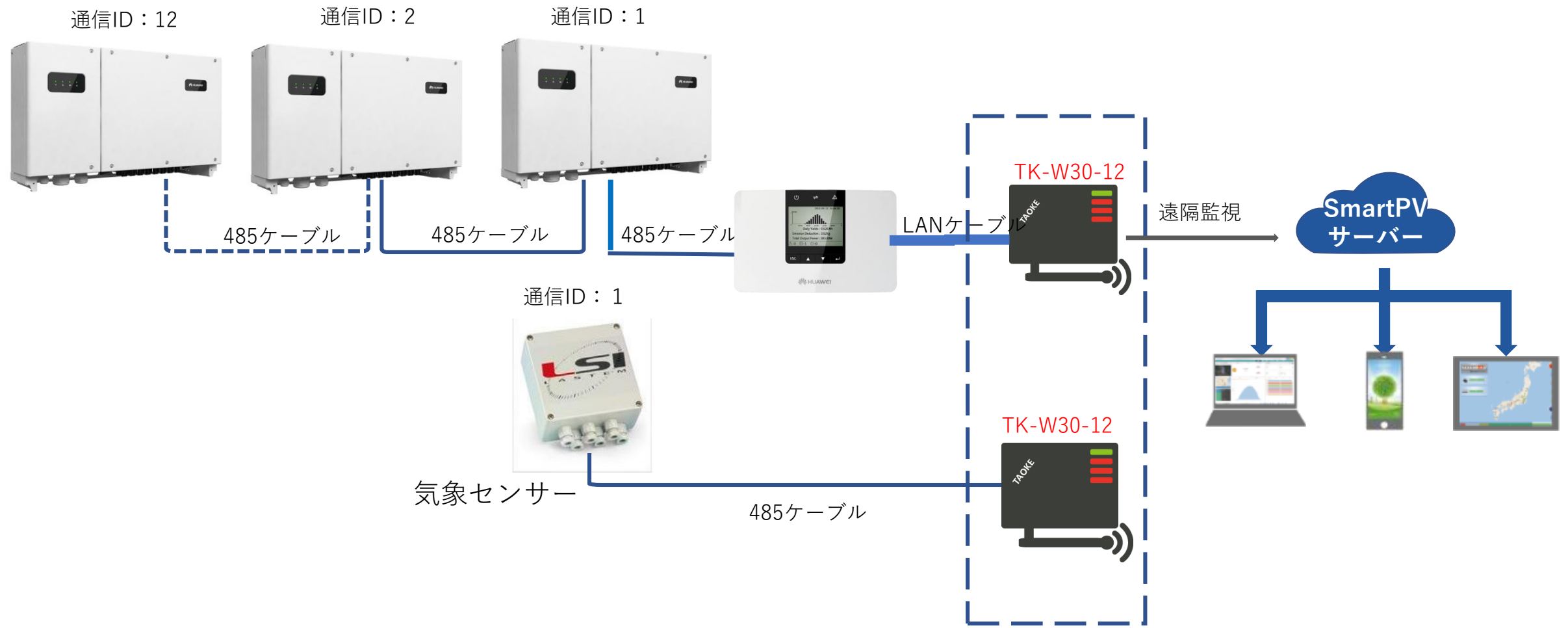

Smartloggerと直結 (PCS12台超えた)

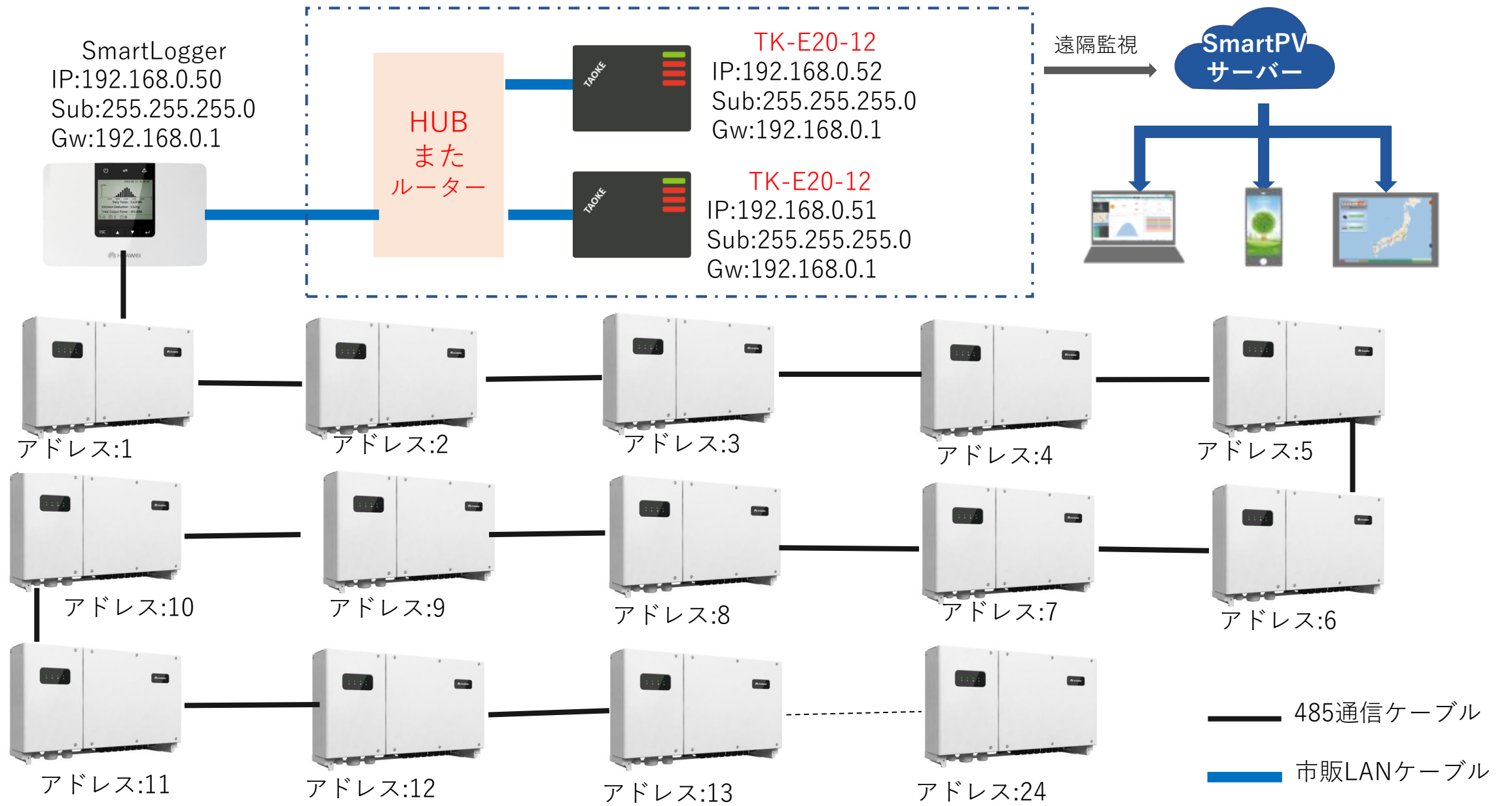

デルタ電子製PCSと直結 (PCS11台まで+気象センサー1台計12台)

気象センサー

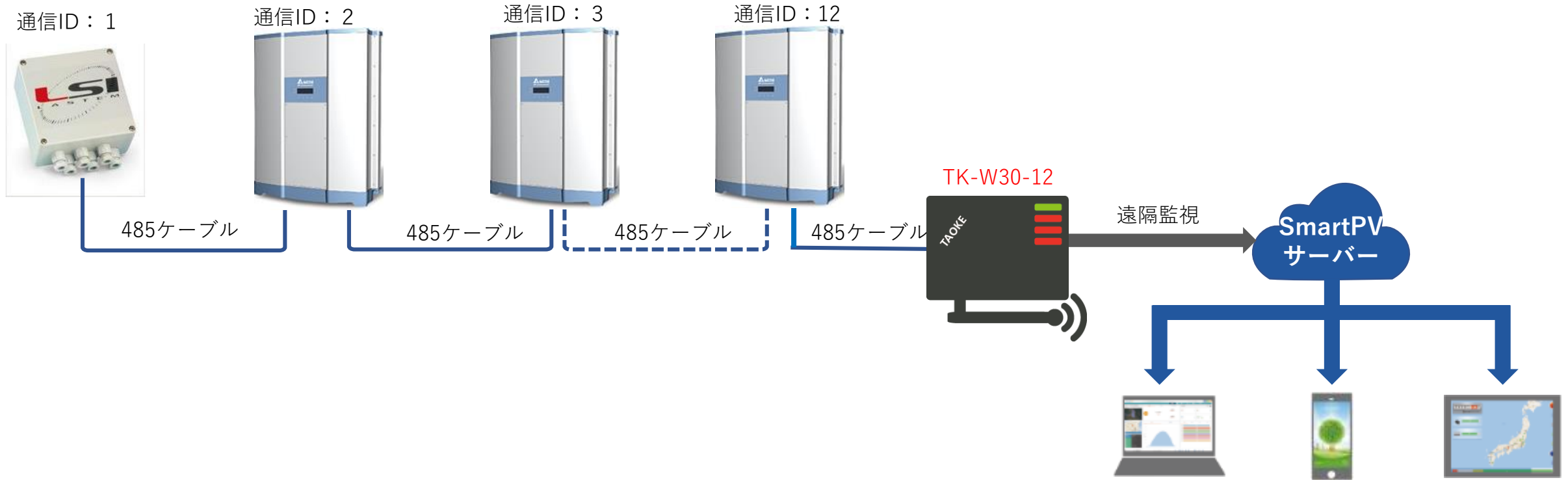

デルタ電子製PCSと直結 (PCS12台超えた+気象センサー1台)

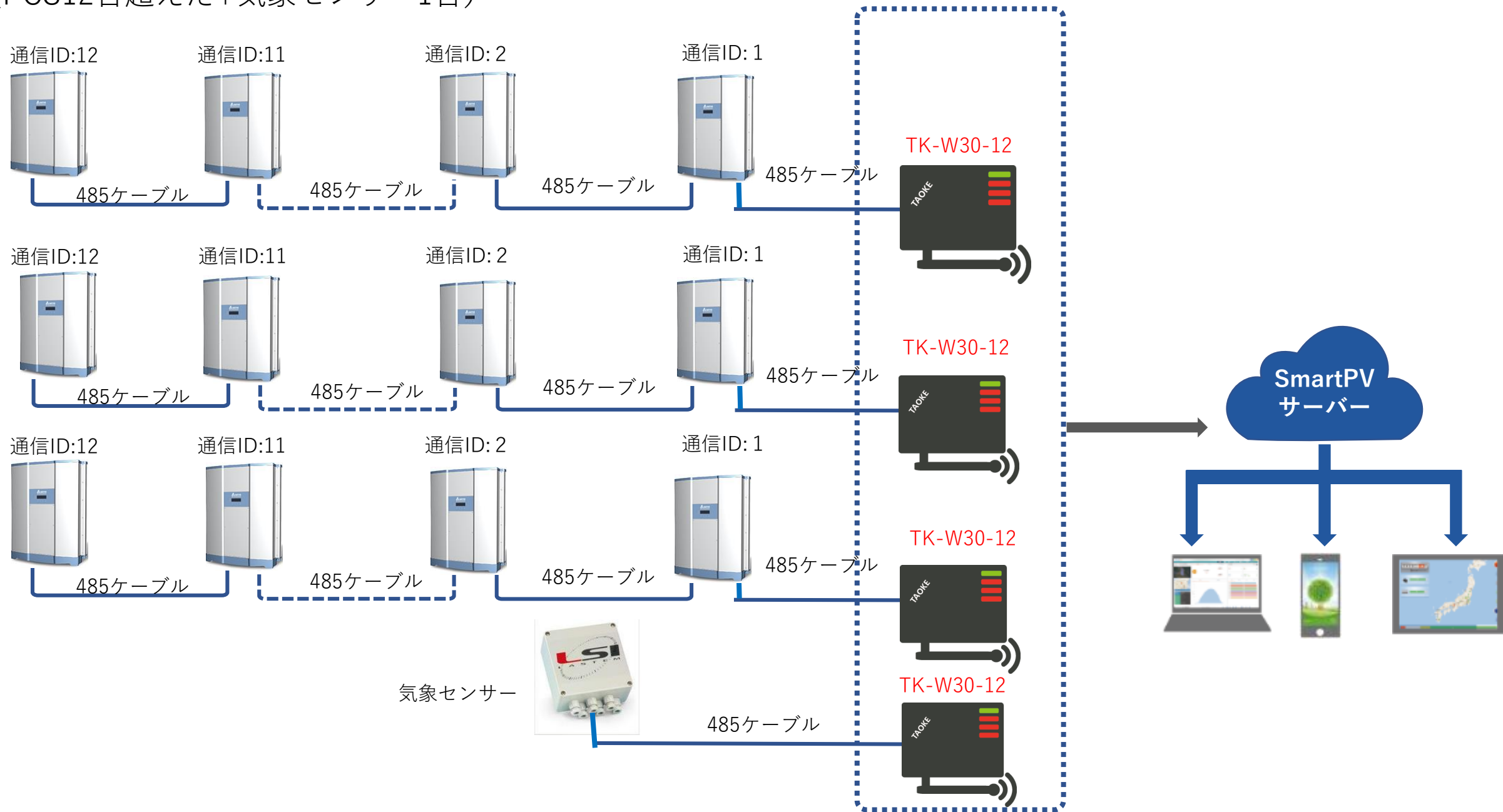

パワーモニタと直結 (PCS11台まで+気象センサー1台計12台)

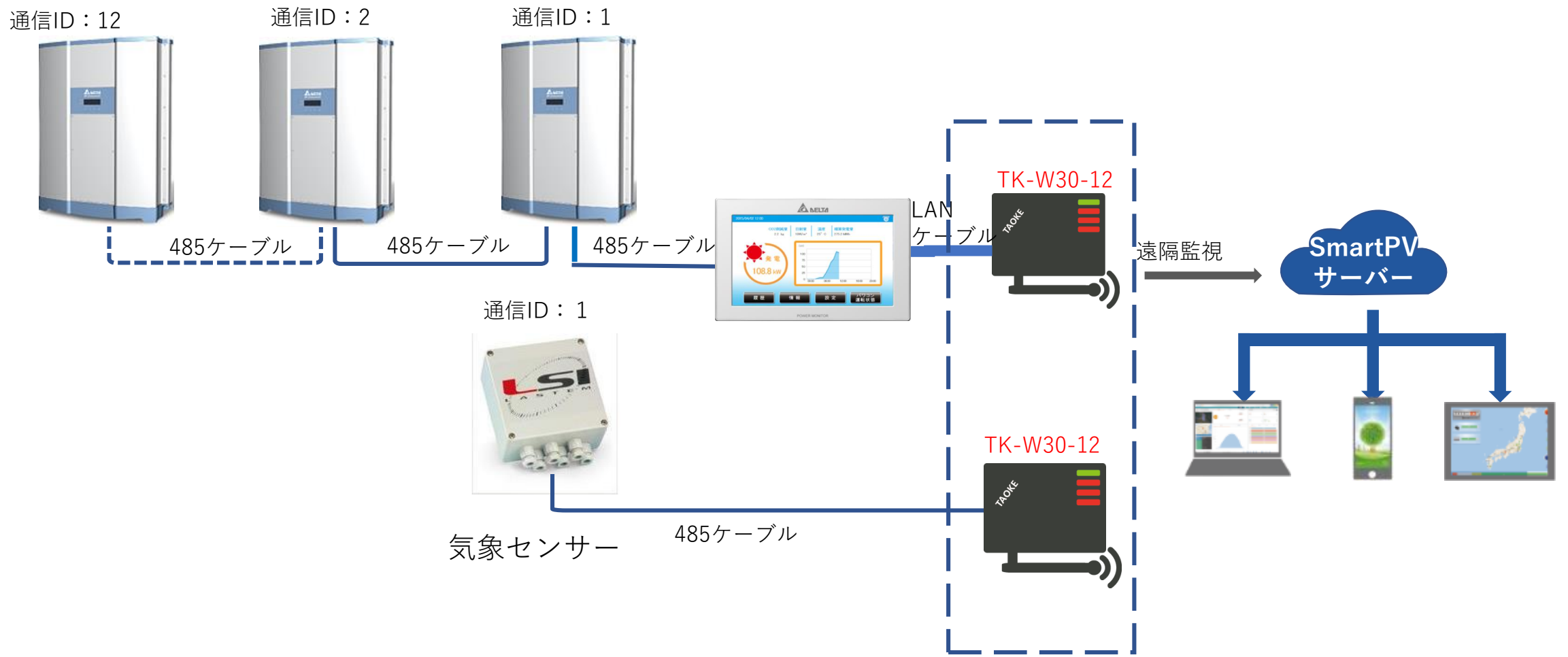

パワーモニターと直結 (PCS12台超えた)

デルタ製パワーモニター
IP:192.168.0.50
Sub:255.255.255.0
Gw:192.168.0.1

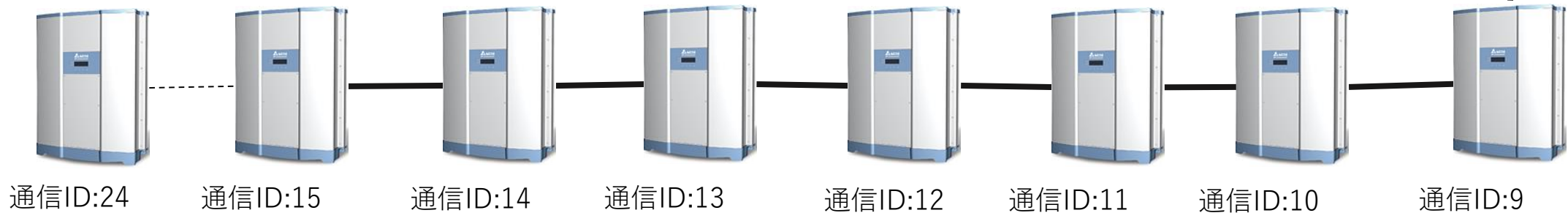
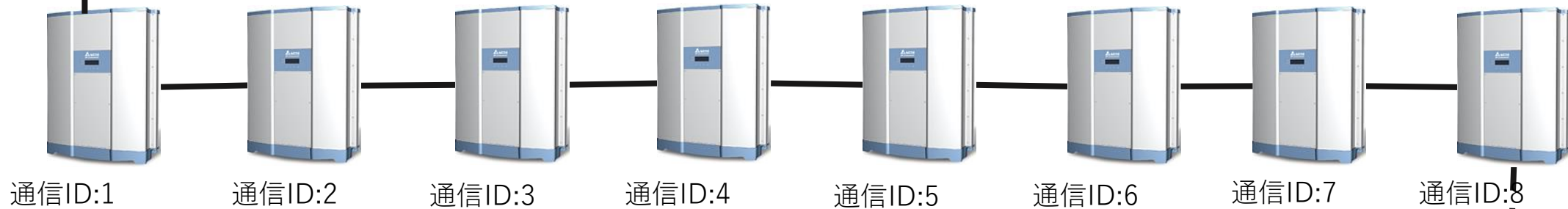
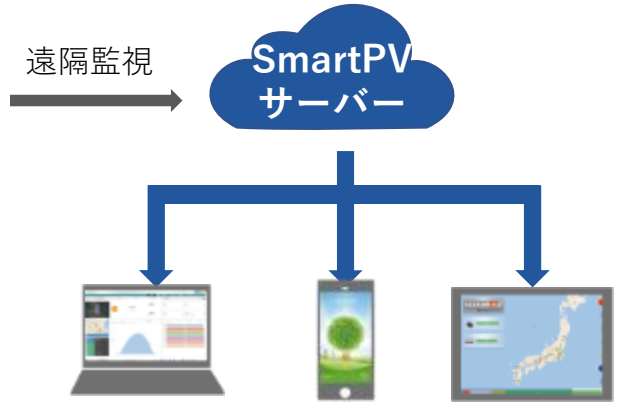
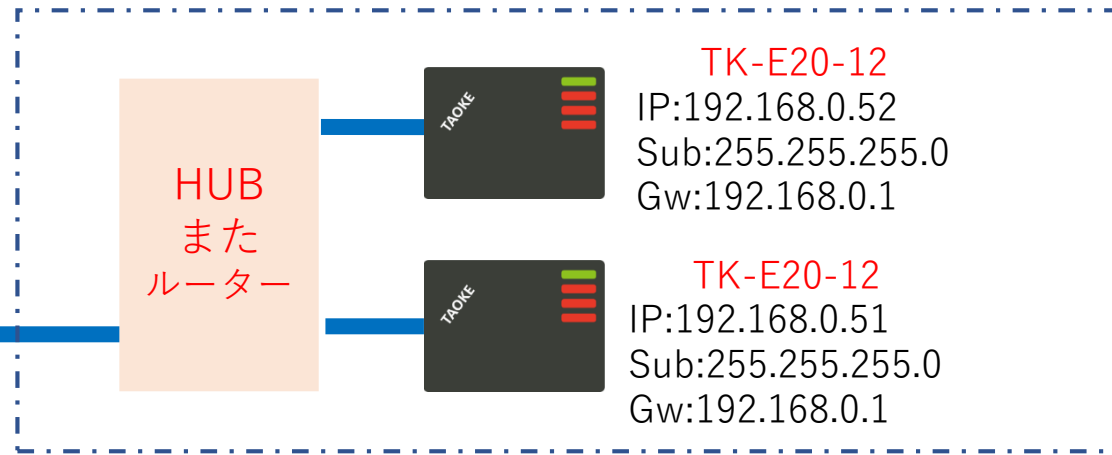

— 485通信ケーブル

— 市販LANケーブル

その他のセントラルPCSと接続

